

# ponyzero

SUSTAINABLE URBAN LOGISTICS

# Market Opportunity



In Italy, the delivery industry is growing despite the economic crisis, according to an Aicai investigation. **It bills 27,7 billion of Euros.** The efficiency loss in City areas represent almost 10 billions of euros, with high costs in transport and long delivery time.



## Last Mile:

The urban delivery market of 0-5kg in Italy is worth 1BN  
The deliveries linked to e-commerce are growing of the 20% each year and it is the most successful market of our country



## Food delivery:

The italian market is worth 400ml

# The Problem



**Limits:**

ZTL free Access

**Fleet Costs:**

Gasoline

Insurance

Maintenance

**Pollution:**

Air&noise

**Traffic:**

In evadine it

8/10 DELIVERY/h  
delivery costs: 2,5€/package

# The Solution



## Limits:

ZTL free Access

## Fleet Costs:

NO Gasoline

Insurance 85% less

Maintenance 70% less

## NO Pollution:

Air&noise

## Traffic:

In evadine it

15/20 DELIVERY/h  
delivery costs: 1,75€/package

# Our Software

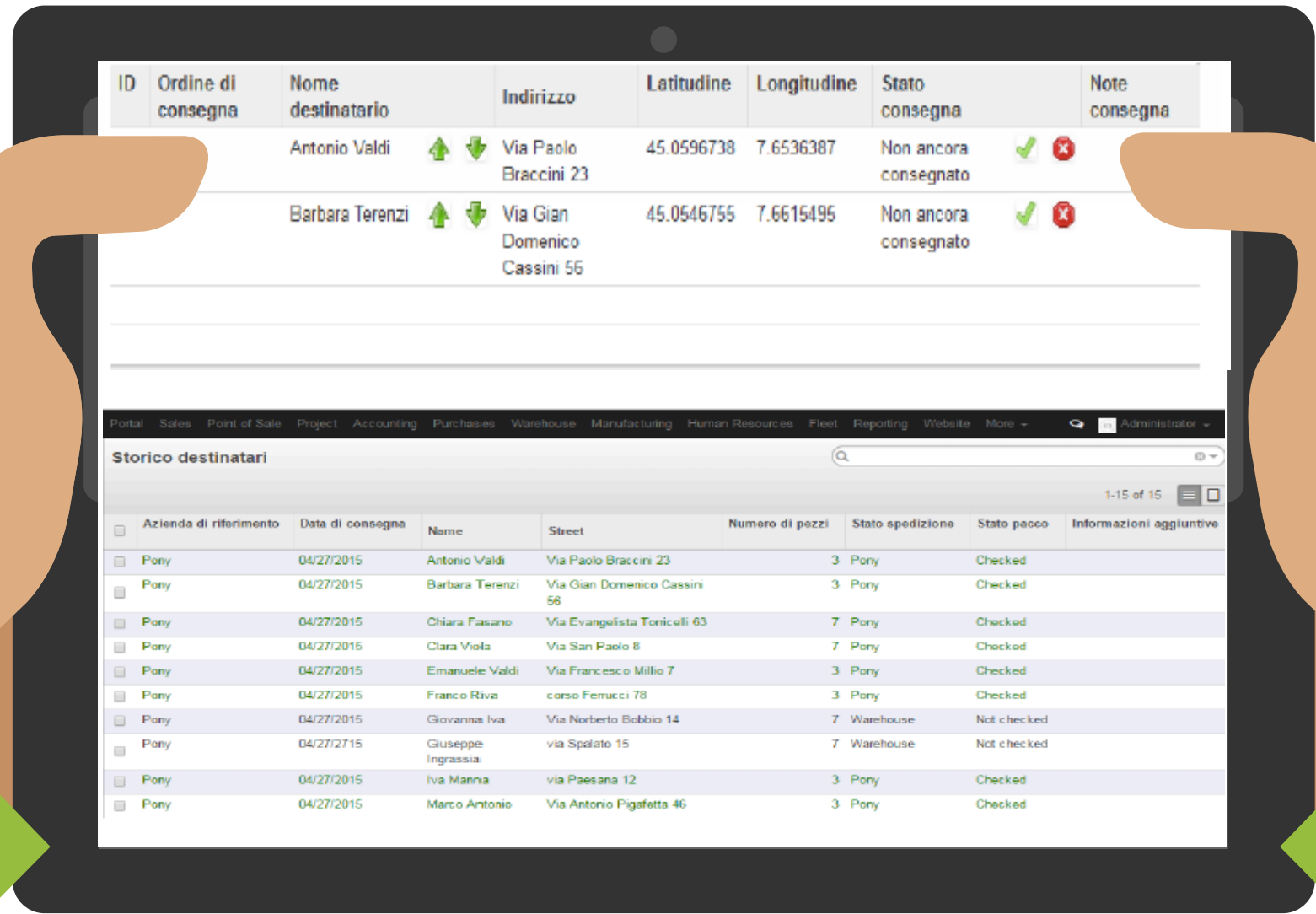

ponyzero

Pony Zero deliveries are assigned to each biker following a **proprietary algorithm**.

# Optimizing Routes

The algorithm calculates the best possible route for each biker, optimizing their delivery route, the time, distances travelled and prioritizing specific time slots

The biker is able to check any delivery details utilizing an App on his smartphone at any time. He can view a real time map in order to navigate and report to center manager any potential delivery issue that may occur.

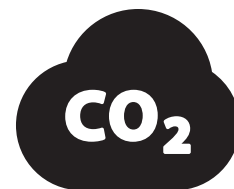

The software calculates the amount of CO2 released



# Issue Management



01 BROKEN BYCICLE

BICYCLE REPLACEMENT WITHIN 30 MIN.

02 SHUTTLE DELAY

ADDITION OF BIKERS AND BICYCLES

03 SOFTWARE MALFUNCTION

DISASTER RECOVERY- DISPATCHING EXCEL

# Satellite Control



Control over the entire group of vehicles



Verification of established routes and routes monitoring

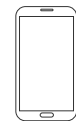

Real time communication with drivers by exchanging direct messages



Real time tracking and geolocation



Journey locked and security granted (departure control, loading-unloading points, distance covered)



# Shipments Safety

LEVEL	RESISTENCE
IPX0	Not protected
IPX1	Protected against vertical dripping
IPX2	Protected against dripping of a 15° maximum inclination
IPX3	Protected against rain fall
IPX4	Protected against water splashes
IPX5	Protected against jets of water
<b>IPX6</b>	<b>Protected against water waves</b>
IPX7	Protected against temporary immersion
IPX8	Protected against ongoing immersion

**RESEARCH AND DEVELOPMENT:**

BOX DESIGNED AND MANUFACTURED EXCLUSIVELY BY AND FOR PONYZERO  
 Its lightness and strength make this the most suitable box capable of carrying packages on a cargo bike.

**Material:** aluminum

**Thickness :** 1,5mm

Waterproof and water resistance (IPX6 International protection standards)

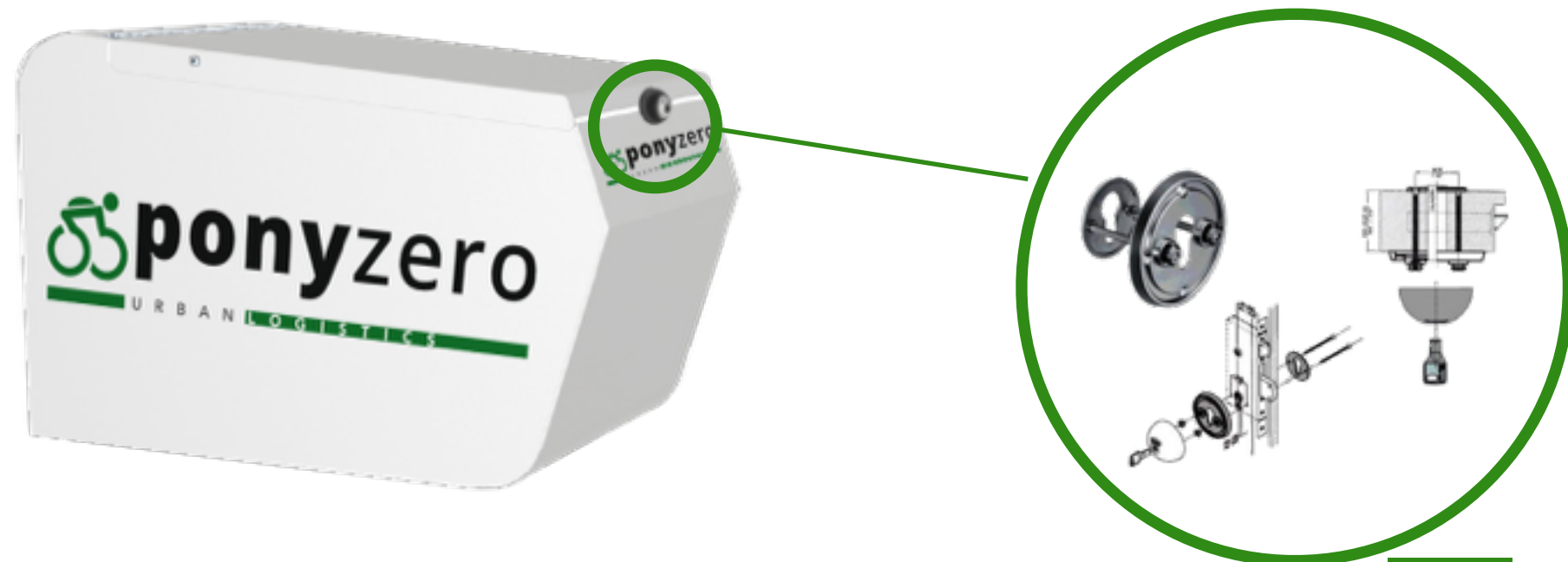

# Documentation & Insurance

DUVRI



DURC

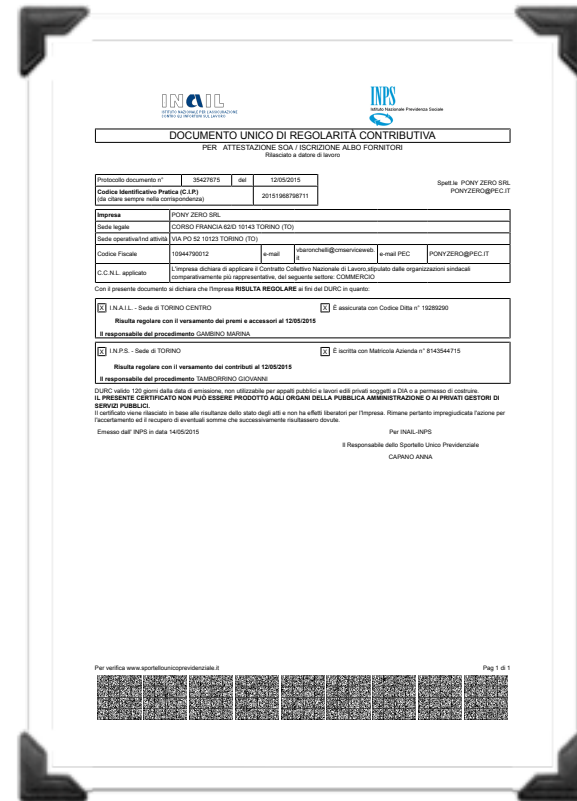

TRANSPORTS REGISTER FOR THIRD PARTY CERTIFICATION

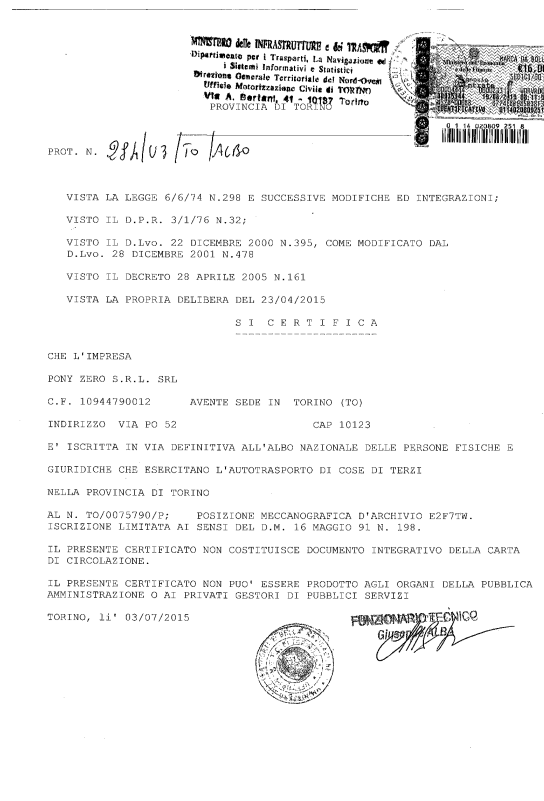

Insurance policy ALL RISK all goods



Fedit member



# The Fleet

## AS IS

Cargo bike 

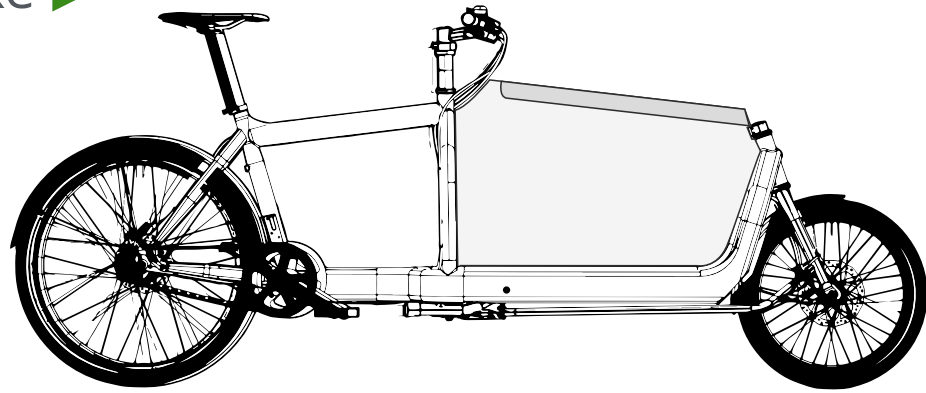

Tricycle bike 

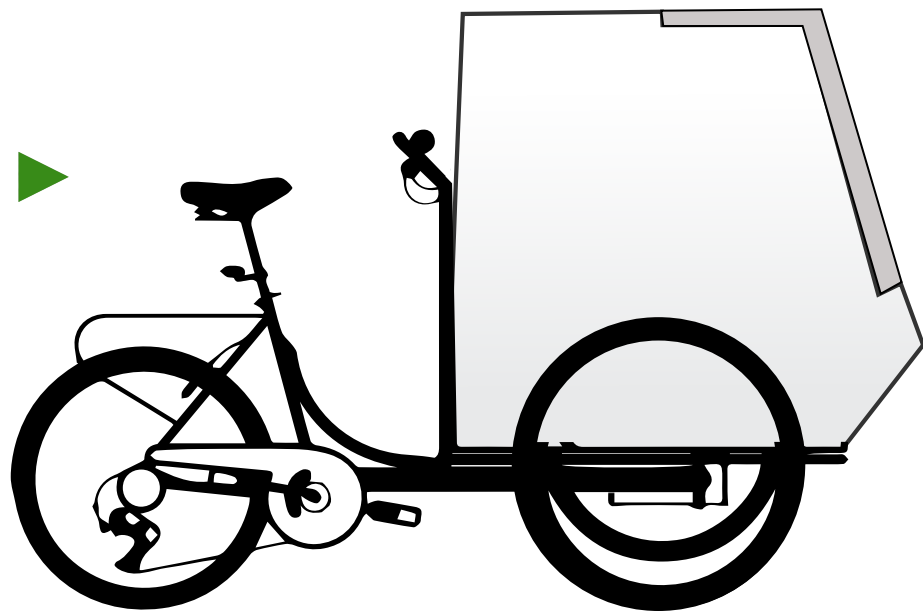

## TO BE

Cargo bike 

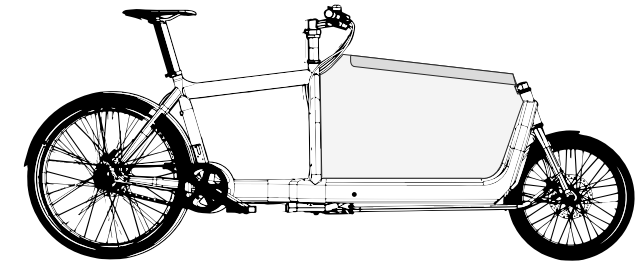

Tricycle bike 

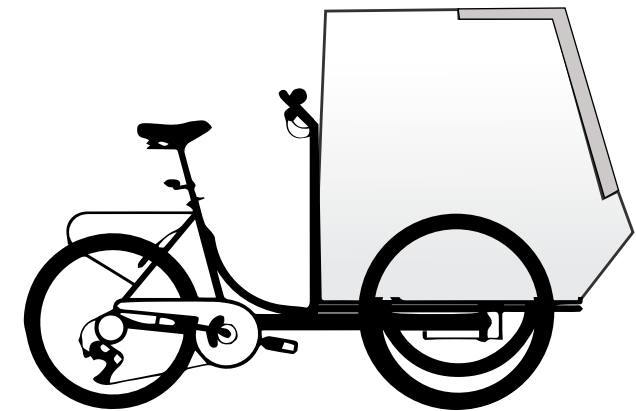

Electric van 



# Our Main Clients



LAST MILE  
INTERNATIONAL SHIPPERS



FOOD DELIVERY  
E-COMMERCE -  
RESTAURANT DELIVERY

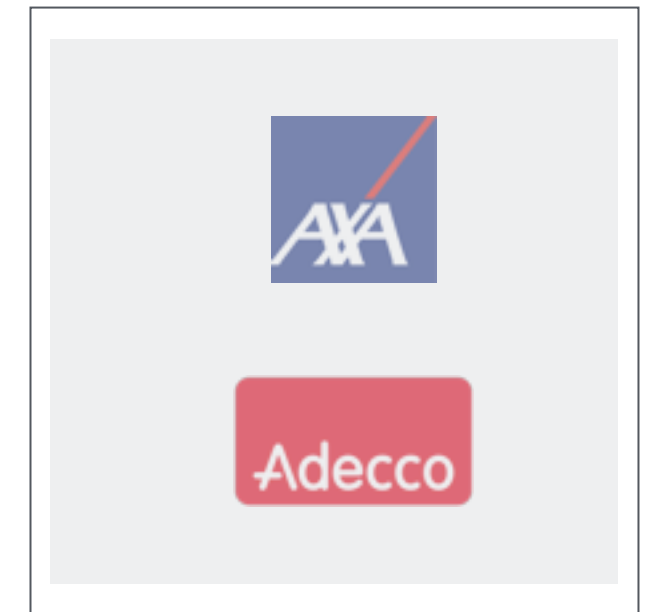

PONY EXPRESS  
RETAIL, PMI

COMPETITOR

	BRAND	EXECUTION	APP	ALGORITHM	TEAM	TRANSPORT
	P O N Y Z E R O	■	■	■	■	■
	O R O B I C I	/	/	/	■	/
	U B M	■	/	/	■	/
	T R I C L O '	/	/	/	■	■

# Our Financials

## A C H I E V E D

## P R O J E C T I O N

YEAR	2013	2014	2015	2016	2017	2018
REVENUES	20K	100K	523K	2,5M	5M	7M

### January 2016 Results 72k

In 2017 we are planning our internationalization. The business plan is being processed

### Capital raised: 700k

Hypothesis capital needed for internationalization: 1M

Turnover expected of 10M in 2 years

Medium EBITDA expected in 5 years: 30%

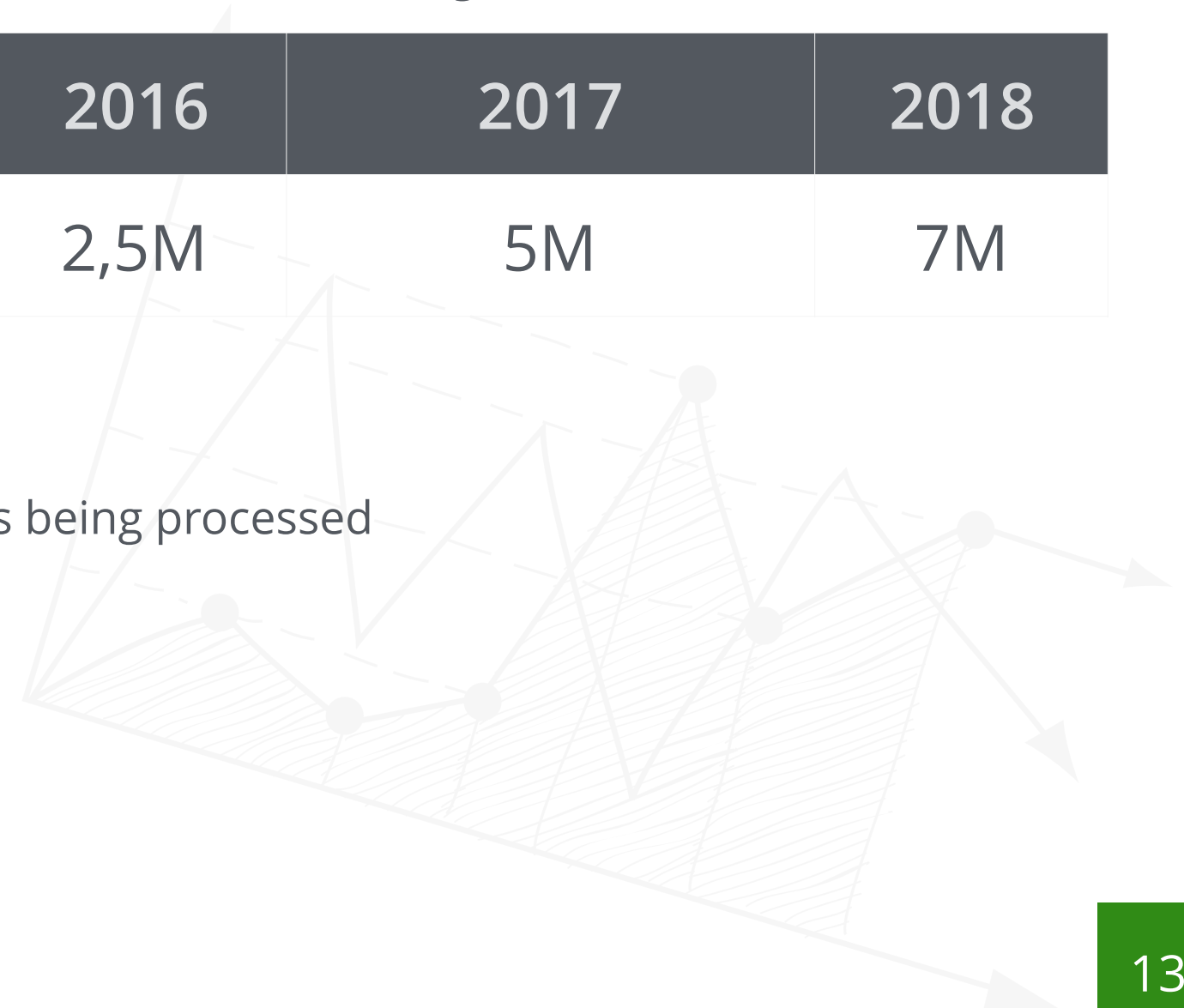

# PonyZero Center



MILAN



TURIN



BOLOGNA

T O D A Y

# Our Development



## Next PonyZero openings

- FLORENCE
- ROME
- 30 ITALIAN CITIES



## Internationalization

- **IN EUROPE:**  
FRANCE, SPAIN, GERMANY  
AUSTRIA, POLAND

# Our Milestones

## ACHIEVED



TURIN



MILAN



BOLOGNA



FLORENCE



GENOA



ROME

## TO BE

### GROWING STRATEGY

Industrial integration with Mail Boxes Worldwide Etc...

It will enable us to offer our services to all network affiliates (1600+ around the World)

Key accounting strategy with the aim of learning important contracts with courier companies and e-commerce (like UPS, BRT, DHL, Amazon and Zalando. Negotiations already underway)

Growth by acquisition (of 2 Italian competitor).



# Our Team



**Marco Actis**  
*ceo & founder*



**Davide Fuggetta**  
*cto & founder*



**Alessandro Mohammadi**  
*public affair manager*



**Alessandro Mina**  
*chief brand officer*



**Paola Lombardi**  
*chief marketing officer*



**Dario Montagnese**  
*chief financial officer*

# ponyzero

SUSTAINABLE URBAN LOGISTICS